

Mixed-mode S parameters modeling with COMSOL Multiphysics

Sophie de Préville¹, Hervé Eusèbe¹, Thierry Goldhorn², Roland Rozsnyo¹

¹hepia, University of Applied Sciences and Arts Western Switzerland (HES-SO), Geneva 1202, Switzerland

²Fischer Connectors SA, Saint-Prex 1162, Switzerland

Abstract: This paper analyses the mixed-mode S parameters in electrical connectors used for data transmission through the standards used in communication protocols.

The first part introduces the type of connectors used and the goals of the study. The second part is a theoretical part explaining what S parameters are. The third and fourth parts are the modeling of electromagnetic waves with COMSOL Multiphysics in the said connectors. Some results are presented in the fifth part: return loss (RL) and transverse conversion transfer loss (TCTL). The last part is dedicated to the presentation of the COMSOL application developed to improve the process conception of electrical connectors.

Keywords: electrical connectors, mixed-mode S parameter, electromagnetic wave modeling

1. Introduction

As represented in Figure 1 [1], connectors are made of two main blocs, called « male » and « female » parts (beige color), surrounded by metallic bodies (grey, black). The blocs contain electrical conductors (gold) in an isolating [dielectric] material (yellow). The surrounding bodies have a mechanical function, maintaining the assembly, and an electric function, as electromagnetic shield.



Figure 1 - Example of a connector - CAD model

The applications of the connectors presented here are for data transmission using digital

protocols, such as UBS3 or Ethernet. Following the specifications indicated in these standards, we are interested in simulating S parameters, more precisely the mixed modes, as RL, IL and NEXT.

Our purpose is to simulate the mixed-mode S parameters and compare the results to the specifications of protocols (USB3 and Ethernet) that establish standards for an assembly of cable and connector. Here we model only the connector.

We also provide here a « simplified model » to study how geometries or materials affect the behavior of S parameters.

2. S parameters

a. Single-ended modes

In Figure 2 [2], the system, unbalanced, defines a signal relative to a common ground. This kind of system is sensitive to errors and electromagnetic interferences.

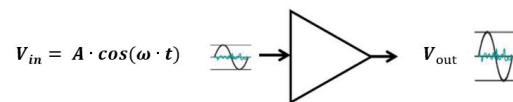

Figure 2 - Single signal

b. Mixed modes

In Figure 3 [2], the system, balanced, defines two inputs as one port. Each input signal is defined relative to a virtual ground. This system is called « differential ». Both input signals have the same amplitude but in opposite-phase.

Compared to the single-ended system, it has better characteristics: less interferences, better noise immunity, and better CMRR¹.

¹ Common Mode Rejection Ratio

However it implies two conductors for each signal [2].

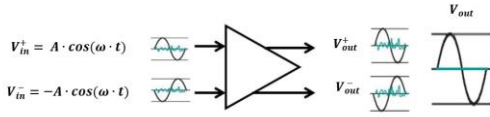

Figure 3 - Differential signal

c. S-matrix

Based on the systems presented before, we can write the S-matrix that characterizes the transmission and reflection signals [3].

For single ended modes, each port is alternately an input or output.

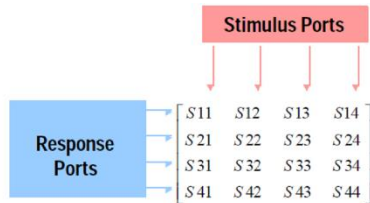

Figure 4 - Single mode matrix

For the mixed-mode, each combination of two ports is alternately an input or output and the type of signal is defined either as differential or common [3].

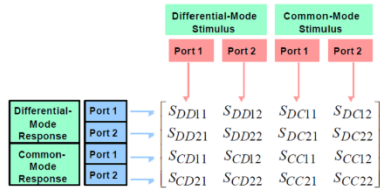

Figure 5 - Mixed mode matrix

A conversion matrix (M) allows calculating mixed-mode matrix (S_{mm}) from single-ended matrix (S) [4].

$$S_{mm} = M \cdot S \cdot M^{-1} \quad (1)$$

These parameters are classified as follow:

- Loss as return (RL) and insertion (IL)
- Crosstalk as near end (NEXT) or far end (FEXT)

- Transverse conversion loss as TCL or TCTL

Other parameters exist, however they are not introduced here.

3. COMSOL models

3.1 Two models

« Complete model »: direct importation of CAD model with little geometrical adjustments to avoid common meshing problems. See Figure 1.

« Simplified model »: geometrical simplification by the removal of most of thin details and surrounding bodies.

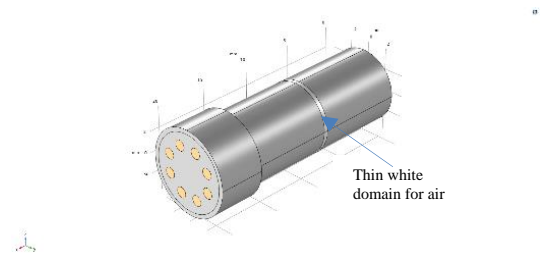

Figure 6 - Simplified model of the connector in Figure 1

According to the choices made to provide a simplified model, only the connector for the Ethernet protocol will be tested in its simplified form (Figure 6). In order to simulate the propagation of EM waves in the air, an additional domain is created to link the two blocs. See results in section 5.B.

3.2 Mixed-mode condition

For input and output of signals a « port » condition is added.

COMSOL v5.5 provides functionality for « mixed-mode » that is a welcome novelty. It allows computing the equation (1) presented in the previous section.

In fact, single-ended modes are simulated. Mixed-modes are obtained by computation with the S and M matrices.

3.3 Materials properties

The material characteristics are the following: the relative permittivity ϵ_r , the relative permeability μ_r , the loss tangent factor $\tan(\delta)$ and the conductivity σ [5], of the following materials: PEEK for the blocs, Silicone for the isolating part, Conductors, originally in copper, are replaced by PEC condition, Air for the remaining part (vacuum space).

3.4 Meshing

Automatic meshing is set to « normal » for both models.

4. Comparison of mixed-mode condition

As introduced in the previous section, COMSOL v5.5 added a new functionality « mixed-mode S parameter » to compute mixed-modes from single modes. For each model « Complete » and « Simplified » we used this condition. As our connectors have more than 2-ports (each side), we also apply this condition.

4.1 Two computations

« All ports »: this means that every conductor has a port condition. The result of the computation in Equation 1 is then manually established.

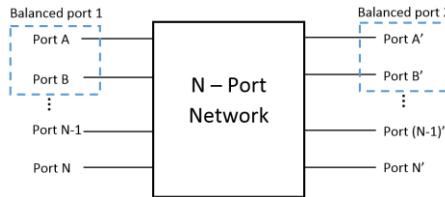

Figure 7 – N-ports configuration

« MMc » (= mixed-mode condition) : only four ports are imposed. Mixed-modes are directly available.



Figure 8 – 4-ports configuration

5. Simulation results

A. Complete model

We present here the results compared to experimental measurements² [1] for a connector used for a USB3.0 protocol³.

Range frequency: 0.5 to 8 GHz.

We plot simulation curves for the complete model only:

- Red dot line : « All ports »
- Blue dot line : « MMc »

Transverse conversion transfer loss (TCTL)

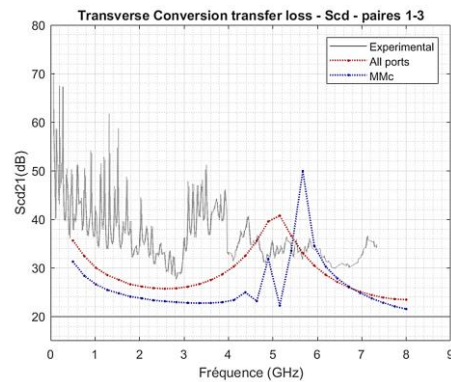

Figure 9 – TCTL for USB3 connector

For TCTL, we observe that our simulations are still in the range of magnitude compared to experimental data and as required by the standard (here defined by the 20 dB line).

B. Simplified model

A second connector, used for Ethernet cat6a protocol⁴, is first simulated in its complete version and then in its simplified version.

Range frequency: 50 to 500 MHz

Here are the results. We plot 5 curves:

- Yellow : Experimental measurement

² Measurements made by an external laboratory on assembly. No signal treatments applied.

³ « Universal Serial Bus 3.0 Connectors and Cable Assemblies Compliance Document ». In: (Oct.,2011).

⁴ « IEEE Standard for Ethernet ». In: IEEE Std 802.3-2018 (Revision of IEEE Std 802.3-2015)(Aug. 2018), p. 1–5600. ISSN: null. DOI:10.1109/IEEESTD.2018.8457469.

- Red dot line : All ports for the complete model
- Blue dot line : Mixed mode condition for the complete model
- Red dot : All ports for the simplified model
- Blue dot : Mixed mode condition for the simplified model

NB: Linear representations [not in dB].

Return Loss

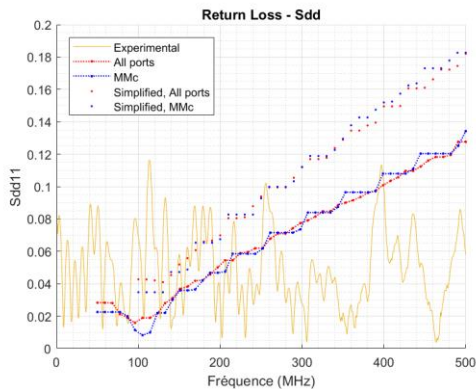

Figure 10 – Return Loss for Ethernet connector

We observe differences between the complete and simplified models. However if we look more closely, we observe the difference between both curve is approximately 3% and 4% compared to the measure.

As presented in section 3.3, relative permittivity is a complex number, the argument of which takes in accounts the losses. However our models do not consider the effects of heat dissipation in the material.

6. Comsol Application

From these two models, complete and simplified, we can conclude few things: results are similar, in the same order of magnitude. In addition, the simulation time for the simplified model is highly reduced compared to the complete one. The small difference in S-parameter is acceptable. The aim of the development of an application is to study the feasibility to provide a tool for the engineer to build 3D model of electrical connectors. This application will be used to study different characteristics as material

or geometrical aspects in order to improve the development of electrical connectors.

The main parameters editable by the user are: Material of each part, geometrical dimension of each part, number of pins and their positions and the protocol.

6.1 Programing

Regarding the implementation, COMSOL interface allows to display easily the basis for an application. To develop a more complex application with more functionalities for the user, some programming is necessary.

A first model almost complete is created. It will be the basis for every simulation. It contains all the necessary, i.e. all the parameters, all the graphs, cards stacking, all the selections, material properties, the report to save the results. All have default values.

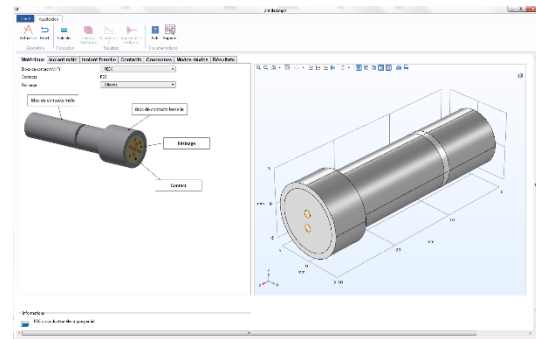

Figure 11 - COMSOL application user interface

7. Conclusion

We compared two models with the « port » condition. The « mixed-mode » option has the advantage that the user doesn't need to enter manually the matrix relation. Moreover, we observed that the results are relevant for insertion loss (IL) and return loss (RL). However, to simulate crosstalk, it seems that to impose « port » condition for every conductor is better.

The comparison between the « complete » and « simplified » models shows the differences are relatively small. In addition, the simplification of the geometry enables a significant reduction in computation time compared to complete models.

For the moment, all the models are lossless. To improve the model, electromagnetic and thermal effect should be taken into account.

To fully answer the criteria listed in the protocol, considering here mixed-mode S parameter, it will be necessary to add the cable in the model. Moreover, protocols have many more specifications, like eye diagram or impedance line, that would be interesting to simulate in order to have a complete model of an assembly.

All these improvements will help to develop a more robust application. This application is mainly dedicated to the engineer of the company. It will also be used as an educational tool to better understand the physic of the electrical connectors.

9. References

[1] Fischer Connectors SA, Company documents

[2] EDN. The differential-signal advantage for communications system design. Feb. 1, 2010. URL : <https://www.edn.com/the-differential-signal-advantage-for-communicationssystem-design/>.

[3] Agilent Technologies. Balanced Device Characterization. Tech. rep. Agilent Technologies.

[4] W. Fan et al. "Mixed-mode S-parameter characterization of differential structures". In: Proc. 5th Electronics Packaging Technology Conf. (EPTC 2003). Dec. 2003, pp. 533–537. DOI: 10.1109/EPTC.2003.1271579

[5] Walter Frei. Modeling of Materials in Wave Electromagnetics Problems. Ed. by COMSOL Blog. May 27, 2015. URL: <https://www.comsol.com/blogs/modeling-of-materialsin-wave-electromagnetics-problems/>.