

Clear paths to teach exergy

Daniel Favrat^a, Malick Kane^b,

^a *Ecole Polytechnique Fédérale de Lausanne (energy center), Lausanne, Switzerland,
daniel.favrat@epfl.ch*

^b *HES-SO//FR, University of Applied Science in Fribourg, Mechanical Engineering Department
(ENERGY Institute), Fribourg, Switzerland, malick.kane@hefr.ch*

Abstract:

This paper proposes a clear path to the exergy balance by subtracting the second Law balance (multiplied by T_a) to the first Law that let appear all the exergy terms. In each exergy terms it is shown that it is essential to clearly distinguish the process-dependent entities from the state functions and how the latter can be visualized in parametric representations including 3D. An opportunity is shown to superpose the various dead states (thermo-mechanical or physicochemical equilibrium). The typical First Law indicators (Effectiveness, coefficient of performance) are compared with the corresponding exergy efficiency for integrated processes including house heating with cogeneration and heat pumps or the valorization of LNG evaporation. From this strong basis the development of both First Law and Exergy efficiencies is shown for a variety of systems providing different energy services in the whole range of temperatures. A much greater coherence of the exergy approach for modern systems including co-or tri-generation is highlighted. The power of the notion of exergy efficiency is further illustrated by comparing various heating or air-conditioning energy systems in urban areas with the possibility to multiply the exergy efficiency of the subsystems to get a coherent ranking of the active technology options. Ultimately, we briefly show how one specific emerging platform (nolej) based on AI could simplify the work of teachers in thermodynamics in general.

Keywords:

Thermodynamics; Teaching; Exergy; Entropy; Exergy efficiency; Effectiveness.

1. Introduction

Exergy is too complicated! That is the too frequent comment coming from practitioners or even physics colleagues. One potential explanation is the fact that, to start with, the entropy concept is often not well understood. In many studies in physics, entropy is essentially introduced in relation to closed system. However, most of the energy systems the engineers deal with, are open systems with the importance of considering the entropy of the masses transiting through the boundaries of the system. As a matter of fact, when asked if they, themselves, have seen their own entropy increase in average during the last year, many would answer yes instead of considering that it is vital for them to keep their entropy constant (at least at constant weight!!). They are also unable to explain why human can still live by 45°C atmospheric temperature or more, while their own body is at 37°C. Heat transfer is not the only way to get rid of one's entropy creation.

One second potential explanation is that while, in the First Law of thermodynamics, the distinction between state functions and process-dependent entities is clearly done with differentiated names, it is often not done with the exergy balance where all terms are called exergy.

One third potential explanation is that the exergy efficiencies, in particular for combustion systems, are numerically much lower than the performance indicators based on the First Law of thermodynamics, reason why the practitioners do not like it. This is in particular relevant for condensing fuel boilers, where First Law "efficiencies" are sometimes quoted with values above 100% due to their use of the Lower Heating Value to characterize the fuel energy input while they condense part of the vapor produced during combustion.

Other obstacles might also be a confusion with the many First Law performance indicators that exist (engine efficiency, efficiency based on Lower Heating Value or on Higher Heating Value, heating coefficient of performance, cooling coefficient of performance) that can be replaced by a single indicator, the exergy efficiency. Also comes into play the potential maximum work that is easily associated to work but not well understood for the other energy outputs like those linked to exiting masses.

2. Exergy balance

2.1. Definition of exergy

The historical path that resulted in a correct and complete interpretation of the First and Second Laws of thermodynamics and their implications has been a lengthy one. It ultimately led to the following definition of exergy, a fundamental concept in the modern approach of the management and proper use of energy:

Exergy: the potential of maximum work that could ideally be obtained from each amount of energy being transferred or stored, using reversible cycles with the environment (atmosphere) as one of the energy sources, either hot or cold.

2.2. Equation of exergy balance

Let us look at a given system surrounded by an environment characterized by its temperature T_a and its pressure P_a .

The First Law of thermodynamics (energy balance) is given by:

$$\begin{array}{cccc} \text{Energy storage} & \text{work} & \text{heat} & \text{energy of transiting masses} \\ \frac{d(U_{cz}+P_aV)}{dt} & = \sum_k \dot{E}_{wk}^+ & + \sum_i \dot{Q}_i^+ - \dot{Q}_a^- & + \sum_j \dot{M}_j^+ h_{czj} \end{array} \quad (1)$$

Or to express the energy conservation:

$$\sum_k \dot{E}_{wk}^+ + \sum_i \dot{Q}_i^+ - \dot{Q}_a^- + \sum_j \dot{M}_j^+ h_{czj} - \frac{d(U_{cz}+P_aV)}{dt} = 0 \quad (2)$$

Power transformation

\dot{Y}^+

The state functions U_{cz} and h_{czj} are defined here as:

$$U_{cz} = U + M \frac{C^2}{2} + MgZ \quad (3)$$

$$h_{czj} = h_j + \frac{C_j^2}{2} + gZ_j \quad (4)$$

Where U_{cz} is the total internal energy including the internal energy U , as well as the kinetic and potential energies. h_{czj} is the total enthalpy per unit mass of the flowing fluid including the specific enthalpy h as well as the specific kinetic and potential energies at the specified state j .

The specific enthalpy h accounts for the specific internal energy and the specific work required to push it into or out of the system, C represents the absolute velocity and Z the altitude. In most practical cases the kinetic and potential terms can be neglected, except when the conditions vary significantly through time or in off-design conditions.

In the above equations, the entities \dot{E}_w^+ , \dot{Q}^+ , \dot{M}^+ can be numerically positive or negative using the convention positive entering indicated by the exponent (+). This allows very compact formulations of the laws. (Later when defining the performance indicators requiring only numerically positive terms the convention positive exiting (-) will also be introduced for some entities).

- \dot{E}_w^+ represents the mechanical energy rate ("work") given to or retrieved from the system (through volume change or rotating shaft for examples),
- \dot{Q}^+ represents the heat rate entering or retrieved from the system from any hot source different from the atmosphere,
- \dot{M}^+ is the input or output (fluid) mass flow of the system,

The notion of *power transformation* \dot{Y} introduced here allows to group all terms concerned with similar masses in networks [1], making sure that the thermodynamic references are coherent, and allowing a simpler definition of the energy services received or provided. A network groups all the masses in a subsystem that are in direct contact with each other. For example, a simple heat exchanger has two networks, one for the fluid being heated and one for the fluid being cooled.

The Second Law of thermodynamics is given by:

$$\begin{array}{cccc} \text{Entropy storage} & \text{entropy of heat} & \text{entropy of masses} & \text{entropy creation} \\ \frac{dS}{dt} & = \sum_i \frac{\dot{Q}_i^+}{T_i} - \frac{\dot{Q}_a^-}{T_a} & + \sum_j \dot{M}_j^+ s_j & + \dot{S}^i \end{array} \quad (5)$$

Where:

- S is the entropy of the system and is a state function while s is a specific state function attached to each mass of the system or moving through its boundary.

- \dot{S}^i is the creation of entropy inside the system, exponent i for internal or irreversibility, and is not a state function but a process-dependent entity. As such \dot{S}^i cannot be determined at a time t, since it needs to be integrated over a time lapse like for work or heat.

In both formulas, the energy or entropy exchanges with the surrounding (atmosphere) have been separated from the other entities, in the same way as Carnot did not include them in his definition of the Carnot efficiency. In quasi-steady operation of open systems, the time derivatives of the state functions S , U_{cz} and V are equal to 0. However, it is not the case for the rate of entropy creation \dot{S}^i since it is not a state function but a process-dependent entity, that requires an integration over time to be quantified. Equation 2 then allows to highlight that any open system needs, not only a cold source but an entropy bin for the entropy of both the heat and the entropy of masses crossing the boundary to compensate for its entropy creation. In quasi-steady operation the entropy of an adiabatic steam turbine does not change, thanks to the fact that the exiting steam has a higher entropy and therefore carry with it the entropy creation occurring in the turbine itself. The same applies to humans or other living creatures that can get rid of their entropy creation through mass transfer [2,3].

Let us multiply the two members of the entropy balance of Equ. (5) by the environmental (atmospheric) temperature T_a so that each term is expressed in energy per unit of time (W), like in the energy balance. Furthermore, since entropy is not conserved in real processes, the term of entropy creation is moved to the right member of the equation:

$$T_a \sum_i \frac{\dot{Q}_i^+}{T_i} - \dot{Q}_a^- + T_a \sum_j \dot{M}_j^+ s_j - T_a \frac{dS}{dt} = -T_a \dot{S}^i \quad (5)$$

Subtracting the latter from the energy balance (Equ. (2)) leads to the **exergy balance** for a system including n networks:

$$\sum_k \dot{E}_{wk}^+ + \sum_i \dot{Q}_i^+ - \dot{Q}_a^- + \sum_j \dot{M}_j^+ h_{czj} - \frac{d(U_{cz} + P_a V)}{dt} = 0$$

$$- \left\{ T_a \sum_i \frac{\dot{Q}_i^+}{T_i} - \dot{Q}_a^- + T_a \sum_j \dot{M}_j^+ s_j - T_a \frac{dS}{dt} = -T_a \dot{S}^i \right\}$$

$\sum_k \dot{E}_{wk}^+ + \sum_i \left(1 - \frac{T_a}{T_i}\right) \dot{Q}_i^+ + \sum_n \left[\sum_j \dot{M}_j^+ (h_{czj} - T_a s_j) - \frac{d(U_{cz} + P_a V - T_a S)}{dt} \right] = T_a \dot{S}^i \quad (6)$

Coenthalpy
coenergy
Work exergy
Heat exergy
Flow exergy
Storage exergy
Exergy loss
 Exergy transformation \dot{E}_y^+ for each of n network

In Equ. (6) all the terms are now **exergy** terms in the same way as all the terms of the First Law are energy terms. However, there is the need to clearly differentiate between state functions and process-dependent entities with a clear denomination. For systems with only work exchange and heat exchanges, these state functions can be expressed as a function of two other state functions (in a given atmosphere for exergy state functions)

Table 1. State functions

First Law and Second state functions	Exergy state functions
Internal energy U or u	Coenergy $J = U + P_a V - T_a S$ or $j = u + P_a v - T_a s$
Total internal energy U_{cz} or u_{cz}	Total coenergy $J_{cz} = U_{cz} + P_a V - T_a S$ or $j_{cz} = u_{cz} + P_a v - T_a s$
Enthalpy H or h	Coenthalpy $K = H - T_a S$ or $k = h - T_a s$
Total enthalpy H_{cz} or h_{cz}	Total coenthalpy $K_{cz} = H_{cz} - T_a S$ or $k_{cz} = h_{cz} - T_a s$

The rate of mechanical (or electric) energy, \dot{E}_w^+ , represents a transfer of energy of the highest thermodynamic quality, such as technical work or electricity, with the system, and as long as such a transfer is done without friction.

According to the definition of exergy given in the introduction, the quantitative values of energy and exergy, for mechanical work or electricity for example, \dot{E}_w^+ , are identical. Let us emphasize that, in this paper, the E_w terms represent the energy terms with the highest potential to provide all kinds of energy services (in this case, equivalent in quantity to exergy). Therefore, it applies to work or electricity terms. The letter E , contrary to many books, is not used to express the total internal energy, which is defined here as U_{cz} . In most practical cases the kinetic and potential terms can be neglected, except when the conditions vary significantly through time or space, or in off-design conditions. This way of writing has also the advantage that the same subscript ($_{cz}$) can be applied to the total enthalpy by symmetry.

The **heat exergy** term $(1 - T_a/T_i)\dot{Q}_i^+$ is the work equivalent of the thermal energy given to the system from a heat reservoir at temperature T_i different from T_a . This expression highlights the multiplicative factor $(1 - T_a/T_i)$ that is nothing other than the so-called *Carnot factor*. This one determines the maximum work that can be produced from a heat rate \dot{Q}_i^+ at temperature T_i when working in an environment at temperature T_a (*Carnot cycle*) with $T_i > T_a$. One key element that needs to be highlighted is that as soon the temperature of the source at T_i is below T_a then \dot{E}_q^+ becomes numerically negative which means that for the system to accept heat, it must provide work, like typically for cooling or refrigeration.

The **flow exergy** term $\dot{M}^+(h_{cz} - T_a s)$, in the absence of chemical reactions, is the maximum work that can be recovered if the considered flow is reversibly brought to a thermal and mechanical equilibrium with the atmosphere. This fact is not obvious at first sight and deserves a demonstration. Figure 1 illustrates the reversible processes that could be used to verify that this expression is the maximum potential work that can be recovered. Those consist first of an isentropic expansion in a turbine until the exit temperature corresponds to T_a , followed by a further expansion in an isothermal turbine until P_a is reached.

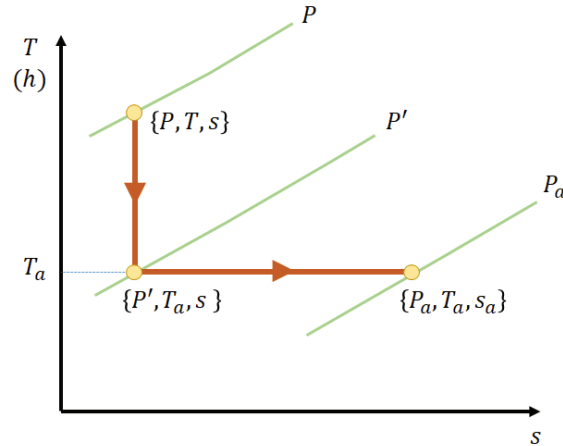

Figure 1. Reversible processes to illustrate that the coenthalpy ($k=h-T_a s$) corresponds to the maximum specific work (exergy) that can be recovered from a mass flow.

The **storage exergy term**, the *total coenergy* $J_{cz} = U_{cz} + P_a V - T_a S$ is the maximum work that is stored in the system and could be recovered at a later stage. It accounts for the internal energy (U), including the kinetic and potential energy (cz), and the mechanical exergy linked to the exchange at the flexible system boundary (like with a piston) with the atmosphere. Again, this concept is not obvious and needs a demonstration to accept it.

Figure 2 illustrates in a (T-s) diagram the reversible processes that could be used to verify that this expression is the maximum potential work that can be recovered from a mass stored in the system. Those consist first of an isentropic expansion in an expander until the exit temperature corresponds to T_a , followed by a further expansion in an isothermal heated expander until P_a is reached. The term $T_a s$ corresponds to the heat received from the atmosphere during these processes. Finally, if the downstream pressure in a general case does not correspond to the atmospheric pressure, then an isentropic compressor might be required as illustrated in Figure 2. Releasing or capturing heat to or from the atmosphere does not, in-itself, imply any exergy exchange since $T=T_a$ and the Carnot factor is null. When it comes to $P_a V$ it should be easy to understand that when the piston of an engine moves downwards, some of the work from the expanding gas is used to push the surrounding atmosphere ($-P_a dV$) but is recovered when the piston goes up, the atmosphere helping. Therefore, it is a true form of energy storage and can be associated to any of the networks in the system.

The **exergy loss term** $T_a \dot{S}^i = \dot{L}$ includes all the exergy losses taking place in the system.

In the same way that the notion of *power transformation* was introduced in the First Law, the corresponding notion of *exergy transformation* grouping the flow exergy and storage exergy terms for each network is also quoted.

Demonstration that the exergy transformation between two different pressures of a gas bottle corresponds to the maximum work that could be retrieved. This case of energy storage with an inert gas, like air, initially pressurized, can be represented by the cylinder-piston device of Figure 2. Equations are the same as for the case of Figure 1 except that the end point is not the state of the atmosphere and we have thus to add a compression process from 2' to 2. The kinetic and potential energies ($)_{cz}$ are neglected.

- a) *isentropic* expansion in an adiabatic expander from $\{P_1, v_1, T_1, s_1\}$ to $\{P_{1'}, v_{1'}, T_a, s_{1'}\}$, that is until the temperature T_a is reached:

$$E_w^- = -(U_{1'} - U_1) - P_a(V_{1'} - V_1) = -M((u_{1'} - u_1) - P_a(v_{1'} - v_1)) \quad (7)$$

b) *isothermal* expansion in a diabatic compressor from $\{P_{1'}, v_1, T_a, s_1\}$ to $\{P_2, v_2, T_a, s_2\}$, heat being received from the atmosphere:

$$E_w^- = -(U_2' - U_1') + Q_a^+ - P_a(V_2' - V_1') = (U_1' - U_2') + T_a(S_2 - S_1) + P_a(V_1' - V_2') \quad (8)$$

c) *isentropic* compression in an adiabatic compressor from $\{P_2, v_2, T_a, s_2\}$ to $\{P_2, v_2, T_a, s_2\}$:

$$E_w^+ = (U_2 - U_2') + P_a(V_2 - V_2') \quad (9)$$

Hence the maximum work that can be recovered is:

$$\begin{aligned} E_{wmax}^- &= -(U_1' - U_1) - P_a(V_1' - V_1) + (U_1' - U_2') + T_a(S_2 - S_1) + P_a(V_1' - V_2') + (U_2 - U_2') + P_a(V_2 - V_2') \\ &= (U_1 - U_2) - T_a(S_1 - S_2) + P_a(V_1 - V_2) = J_1 - J_2 = E_y^- \end{aligned} \quad (10)$$

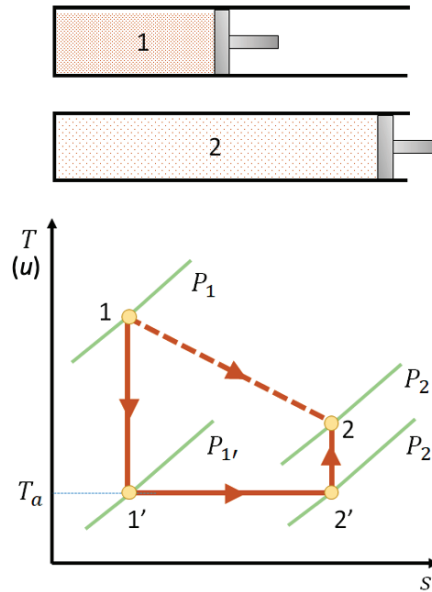

Figure 2. Reversible processes leading to the production of maximum work from the expansion of a given mass of gas in a closed system.

The net maximum work is therefore also the difference of the total coenergies. This is typically the term that will allow us to assess the work that can ideally be recovered in compressed air storage schemes, or from a compressed inert gas in a compressed air car, a technology that some researchers are presently developing for urban driving [4].

2.3 State functions versus process-dependent entities

Note that in the above equations the symbol δ is used in derivatives for process-dependent entities while d is used for state functions.

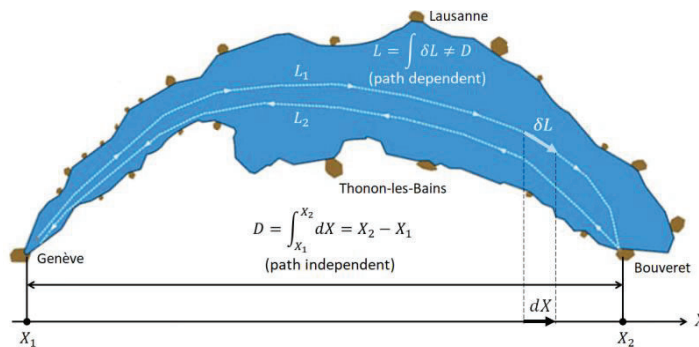

Figure 3. Illustration of the difference between a state function and process-dependent entity

State functions can be defined in any position during a process while process-dependant entities require an integration over the chosen thermodynamic path. Figure 3 symbolically illustrates this difference in the simple example of a boat going from point 1 (“Geneva”) to point 2 (“Bouveret”) and return following a different path, thus of different length ($L_1 \neq L_2$) while the “distance as the crow flies” D between the two cities remains of course unchanged.

In this case the length of the path L is a process-dependent entity while the reference of its horizontal position X is a state function. X_1 and X_2 can be clearly defined, but this is not the case for L that will depend on the path chosen by the skipper that day.

One interesting feature is: $\oint dX = 0$ while $\oint \delta L > 0$

Therefore, we will also have: $\oint \delta S = 0$ while $\oint \delta S^i > 0$

It is important to realize that, even though we are in both cases speaking of entropy, the entropy S within the system is a state function while the creation of entropy **inside** the system S^i is a process-dependent entity.

Q, E_w are also process dependent entities while S, U, H with their specific mass counterparts s, u, h are state functions.

When expressed in function of time we have:

$$\dot{Q}^+ = \frac{\delta Q^+}{dt} \quad (11) ;$$

$$\dot{E}_w^+ = \frac{\delta E_w^+}{dt} \quad (12) ;$$

$$\dot{S}^i = \frac{\delta S^i}{dt} \quad (13)$$

Figures 4 and 5 show the state function *coenergy* of air in function of the temperature and its specific entropy. Similar diagrams can be made for any substance or mixtures of substances.

Energy and masses are conserved, but their potential to do work is ultimately degraded to be cancelled when the equilibrium with the atmosphere is reached, a thermodynamic state that is called the *dead state*.

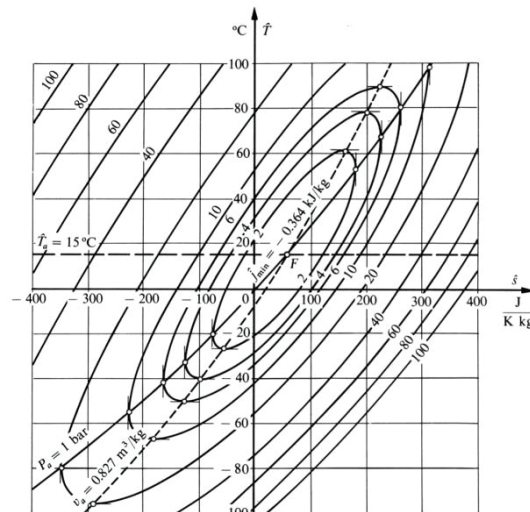

Figure 4. Coenergy of air in a T-s diagram [1]

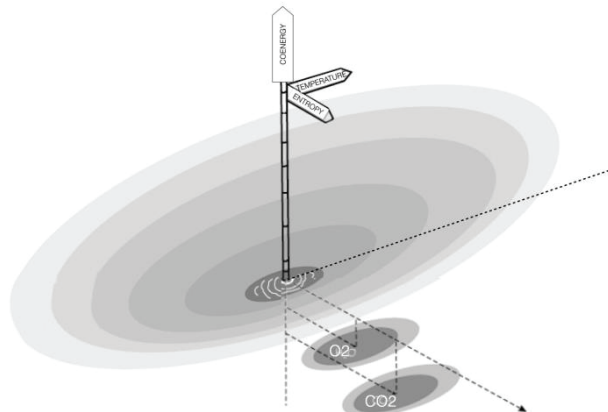

Figure 5. Approximate representation of the coenergy function (here for air) with the thermomechanical dead state at the centre of the bowl, as well as the individual dead states for O_2 and CO_2

Those diagrams illustrate the existence of different *dead states*:

- The *dead state* of the mixture corresponding to the thermo-mechanical equilibrium with the environment (atmosphere). It corresponds to the bottom of a bowl where the coenergy has a minimum value. The higher the difference between the absolute value of $(s-s_a)$ or the difference $(T-T_a)$, the higher is the value of the coenergy.
- Two other *dead states* are approximatively represented, one for the physico-chemical equilibrium of the component H_2O of the air mixture and one other for the physico-chemical equilibrium of the component CO_2 . The exergy analysis requires then the definition of a reference composition of the atmosphere shown in Table 2. The latter illustrates the minimum work required to separate CO_2 from air that is now discussed in the context of CO_2 separation for either reuse or storage.

3. Extension to chemical processes

Chemical processes like combustion or oxidation in fuel cells imply a change of substance between the input substances and the products of the reactions. While the sum of the enthalpies of the flows through an open adiabatic system with a combustion process does not change, the reference states for each products have lower values.

Table 2. Partial pressure and molar fractions of the main gaseous constituents of the standard atmosphere (at the standard conditions with $P^0 = 1.01325 \text{ bar}$ and $T^0 = 25^\circ\text{C}$)

Substance	$P_i \text{ [bar]}$	$\tilde{c}_i^A \text{ [kmol}_i\text{/kmol}_A\text{]}$
N_2	0.7665	0.7565
O_2	0.2056	0.2030
Ar	0.0091	0.0090
$H_2O(g)$	0.0316	0.0312
CO_2	0.0003	0.0003

3.1. Fuel exergy value

The analysis of reactive processes, like combustion, can be dealt with by introducing a combustion network with a power transformation term \dot{Y}_{comb}^+ in the energy balance et a combustion exergy transformation term $\dot{E}_{y\,comb}^+$ in the exergy balance. For the latter not only the standard atmosphere (Table 2) should be considered but also the following set of hypotheses:

- The fuel F and the air A enter separately (no premixing with the fuel)
- Each constituent of the reaction products G_c (combustion gases) ends up physically mixed with the standard atmosphere, i.e. at its partial pressure P_i^{00}
- Water exists in the final combustion products G_c either in liquid or vapor form at the limit of saturation, i.e. at the partial pressure of saturation in the standard atmosphere.

These conditions being set, the corresponding values for the **exergy value of a fuel EXV** are the following:

$$EXV = \Delta k^0 = \sum_i \left[\frac{N_i \tilde{k}_{f,i}^{00}}{M_F} \right] - \sum_j \left[\frac{N_j \tilde{k}_{f,j}^{00}}{M_F} \right] \quad \left[\frac{J}{kg_F} \right] \quad (14)$$

In accordance with the basic definition of exergy, the specific exergy value Δk^0 corresponds to the maximum work e_{max}^F that can be recovered from a fuel in an open reversible combustion in steady state (Fig.6).

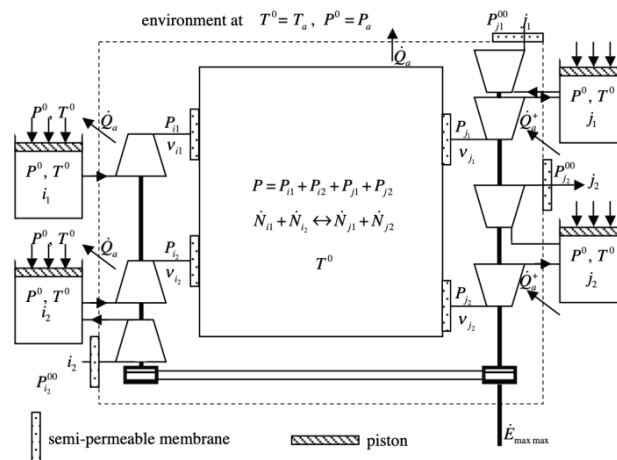

Figure 6. Mechanistic model of a reversible combustion using a van'Hoff's box [1,5]

3.2. Energy and exergy balances including power- or exergy- transformation for the combustion network

In principle, we should also consider whether or not there is condensation of the water formed during combustion. However as shown in [1] the difference between a higher and a lower exergy value is negligible in particular when $T_a = T^0$. This is logical since the Carnot factor $(1 - \frac{T_a}{T^0})$ is zero. Hence **the advantage of the exergy analysis of systems including oxidation processes is that a single fuel exergy value can be considered in first approximation.**

Energy balance
$\sum_k \dot{E}_{w_k}^- + \sum_i \dot{Q}_i^- (+\dot{Q}_a^-) + \sum_n \dot{Y}_n^- = \sum_k \dot{E}_{w_k}^+ + \sum_i \dot{Q}_i^+ (+\dot{Q}_a^+) + \sum_n \dot{Y}_n^+ + \dot{Y}_{comb}^+ \quad (15)$

$\dot{Y}^+ = \sum_i [\dot{M}_i^+ h_{cz_i}] - d(U_{cz} + P_a V)/dt$ (16) for each of the n system networks, except for the combustion network that is treated separately:

$$\dot{Y}_{comb}^+ = \dot{M}_F(HHV + \hat{h}_F) + \dot{M}_A \hat{h}_A - \dot{M}_G \hat{h}_G - \sum(\dot{M}_I HHV_I) - (\dot{M}_{H_2O_p} - \dot{M}_{cond}) q_{vap}^0 \quad (17)$$

Where:

- $\hat{h}_F = \int_{T^0}^{T^F} dh_F$ and $\hat{h}_A = \int_{T^0}^{T^A} dh_A$ and $\hat{h}_G = \int_{T^0}^{T^G} dh_G$ are the enthalpy differences between the state of the entering or exiting entities considered in the power transformation \dot{Y}_{comb}^+ and the standard conditions. The species in \hat{h}_A and \hat{h}_G are considered to be perfect gases
- \dot{M}_I and HHV_I are the mass-flows of unburned hydrocarbons and their higher heating value, in the case of incomplete combustion,
- $\dot{M}_{H_2O_p}$ is the mass-flow of H_2O produced during combustion,
- \dot{M}_{cond} is the mass-flow of H_2O effectively condensed.

Exergy balance
$\sum_k \dot{E}_{w_k}^- + \sum_i \dot{E}_{q_i}^- + \sum_n \dot{E}_{y_n}^- = \sum_k \dot{E}_{w_k}^+ + \sum_i \dot{E}_{q_i}^+ + \sum_n \dot{E}_{y_n}^+ + \dot{E}_{y,comb}^+ - \dot{L} \quad (18)$

$$\dot{E}_y^+ = \sum_i [\dot{M}_i^+ (h_{cz_i} - T_a s_i)] - d(U_{cz} + P_a V - T_a S)/dt = \sum_i [\dot{M}_i^+ k_{cz_i}] - dJ_{cz}/dt \quad (19)$$

for each of the n system networks except for the combustion network that is treated separately:

$$\dot{E}_{y,comb}^+ = \dot{M}_F (EXV + \hat{k}_F) + \dot{M}_A \hat{k}_A - \dot{M}_G \hat{k}_G - \sum[\dot{M}_I \Delta k_I^0] \quad (20)$$

(Specific isobaric) fuel exergy value

$$EXV = \Delta k^0 = \sum_i \left[\frac{N_i \hat{k}_{f_i}^0}{M_F} \right] - \sum_j \left[\frac{N_j \hat{k}_{f_j}^0}{M_F} \right] \quad \text{in} \left[\frac{J}{kg_F} \right] \quad (21)$$

or

$$\Delta \tilde{k}^0 = \Delta \tilde{g}_F^0 + \sum_j [\tilde{e}_{d_j}^0] - \sum_i [\tilde{e}_{d_i}^0] \quad \text{in} \left[\frac{J}{kmol_F} \right] \quad \text{with} \quad \tilde{e}_{dk}^0 = \frac{\dot{N}_k}{\dot{N}_F} \tilde{r} T^0 \ln \left(\frac{p^0}{p_{k,0}^0} \right) \quad (22)$$

Where $\Delta \tilde{g}_F^0$ is the Gibbs free energy (free enthalpy) of the fuel based on the enthalpies of formation and the absolute entropies. \tilde{e}_{dk}^0 is the exergy of diffusion (often called chemical exergy of the inert species).

4. Energy and exergy performance indicators

Historically Carnot developed its engine efficiency based only on energy terms. When the process is reversed this definition of efficiency becomes higher than 1 for heating or ≤ 1 for cooling, reason why COP heating or COP cooling have been introduced. We prefer the introduction of the concept of effectiveness adapted to all cases even if there is still the need to differentiate between heating and cooling effectivenesses when dealing with First Law energy terms.

This issue is not a problem with the notion of exergy efficiency where one definition only can be used for all systems with values remaining lower or equal to 1.

Providing energy services can be achieved by various technologies or combinations of technologies and it is important to be able to characterize the quality of these different options. In practice, two different indicators of the quality of energy processes can be defined: the (*energy*) **effectiveness** (so-called "thermal efficiency" or "coefficient of performance") based on the First Law of thermodynamics only or, better, the **exergy efficiency** based on the exergy balance, thus accounting for both the First and the Second Laws of thermodynamics. The basic idea of these sets of performance indicators is to use:

$\varepsilon \text{ (or } \eta) = \frac{\text{energy (or exergy) services provided by the system}}{\text{energy (or exergy) services received by the system}} \quad (22)$

The *energy effectiveness* can be formulated as follows:

$$\varepsilon = \frac{\sum_k \dot{E}_{w_k}^- + \sum_i \dot{Q}_i^- + \sum_n \dot{Y}_n^-}{\sum_k \dot{E}_{w_k}^+ + \sum_i \dot{Q}_i^+ + \sum_n \dot{Y}_n^+} \quad \text{valid for processes at } T \geq T_a \quad (23)$$

Written that way, this expression is indeed only valid for processes that take place above the atmospheric temperature and can take values between 0 and ∞ . This formulation can be directly used for engine or heating heat pump cycles. An exception needs to be done for refrigeration for which the refrigeration service \dot{Q}_f^+ or \dot{Y}_f^+ with temperature values lower than T_a must be only considered in the numerator as an energy service provided by the system.

The **exergy efficiency** can then simply be formulated as follows:

$$\eta = \frac{\sum_k \dot{E}_{w_k}^- + \sum_i \dot{E}_{q_i}^- + \sum_n \dot{E}_{y_n}^-}{\sum_k \dot{E}_{w_k}^+ + \sum_i \dot{E}_{q_i}^+ + \sum_n \dot{E}_{y_n}^+} = 1 - \frac{\dot{L}}{\sum_k \dot{E}_{w_k}^+ + \sum_i \dot{E}_{q_i}^+ + \sum_n \dot{E}_{y_n}^+} \leq 1 \quad (24)$$

Note that we consider in the numerator only the exergy services provided to users of the system. When any exergy term of the numerator exits the system without being used, the boundary of the system needs to be extended to the atmosphere and this exergy term becomes zero, but the corresponding exergy losses are still accounted for in \dot{L} since the denominator has not changed. We can say that the related exergy loss is internalized and attributed to the system. For example, if the system is a combustion engine with a generator, its main service is to provide electricity, even though the cooling network has exergy that could potentially be used by others. However, if the exergy of the cooling network is not used but is destroyed in a cooling tower, it is automatically included in the exergy losses \dot{L} . Some authors like [6] subdivide \dot{L} into:

$$\dot{L} = \dot{L}_D + \dot{L}_E \quad (25)$$

Where \dot{L}_D includes the exergy destruction inside the strictly defined system and \dot{L}_E includes the exergy destroyed between the system and the atmosphere. We do not consider this subdivision as useful in practice, since the objective is in fine the reduction of the total exergy loss \dot{L} .

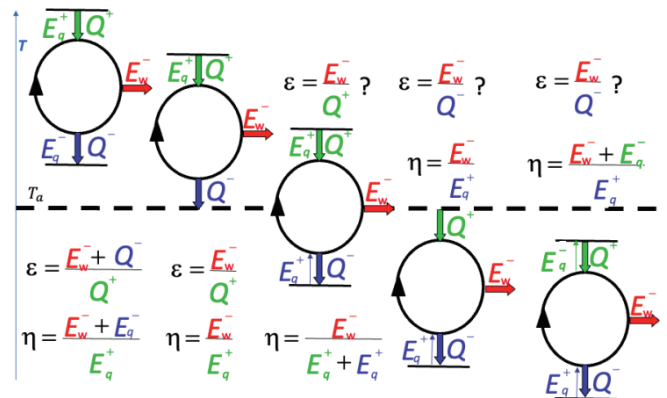

Figure 7. Simple representation of the energy effectiveness and the exergy efficiency of engine cycles in function of the temperature range [1]

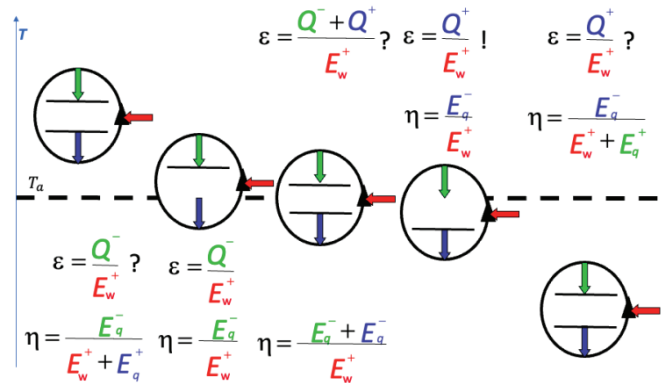

Figure 8. Simple representation of the energy effectiveness and the exergy efficiency of heat pump cycles in function of the temperature range [1]

Figures 7 and 8 show the performance indicators for simple engine cycles and heat pumps cycles in the various temperature ranges. There are clearly situations where defining an effectiveness is problematic while exergy efficiencies are coherent for all cases.

Figure 9 shows a symbolic representation of some common technologies in a 3D bowl diagram. This is inspired from the earlier representations of [1] with an analogy between exergy levels and the gravity field. Mass units are represented by little men. The red arrows show a typical fuel boiler situation starting with a high exergy level fuel combined to give combustion gases at relatively high temperature and specific exergy to provide

heat for a building at low exergy level. Finally heat losses through the walls of the building let energy leak to the dead state. The green arrows represent the processes of an engine requiring, to elevate some of the little men to the high exergy level of electricity some little men need to be going to the dead state all the greater as the initial exergy level is low. An alternative is shown with the downward little men being deviated at the level of the house heating and that corresponds to a cogeneration system. The blue arrows illustrate a direct electric system. The yellow arrow illustrates an electrical heat pump. Finally on the left of the figure is a representation of a sub-atmospheric temperature Rankine engine cycle using the environmental heat as a heat source and the lower temperature of liquid natural gas (LNG) to be evaporated as a cold source.

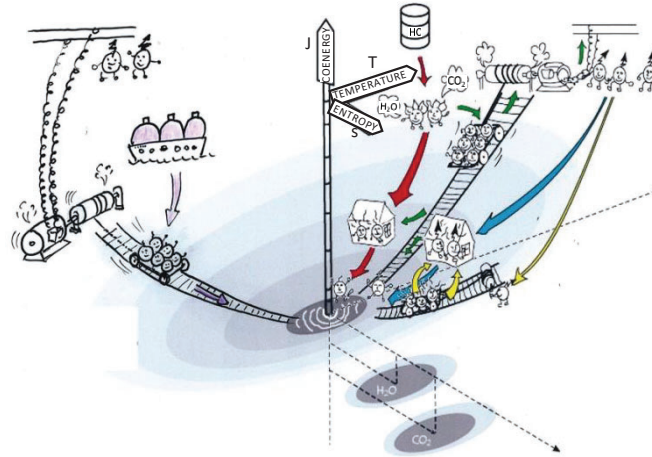

Figure 9: Symbolic representation of the exergy bowl with different heating and power generation technologies [7]. (Rigorously the coenergy bowl should be redrawn for each change of substance)

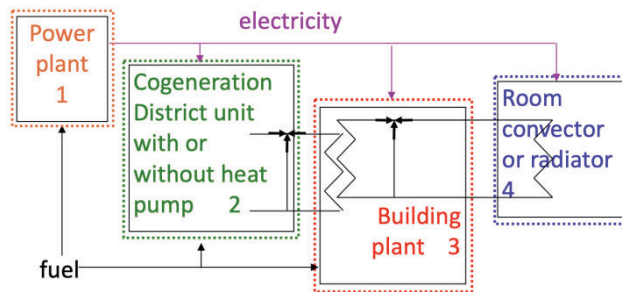

Figure 10. Division in 4 subsystems of the problem of heating or cooling of a building with a multiple choice of technologies [8].

Table 2: Examples of overall technologies for heating

Technologies	Power plant	DH plant	Building plant		Room convector		Overall exergy efficiency (%)	
			45°/35°	65°/55°	45°/35°	65°/55°	45°/35°	65°/55°
Supply/return temperatures			45°/35°	65°/55°	45°/35°	65°/55°	45°/35°	65°/55°
Direct electric heating (hydro power)	0.88				0.07	0.07	6.0	6.0
Building non-condensing boiler			0.11	0.16	0.53	0.38	6.1	6.1
Building condensing boiler			0.12		0.53		6.6	
District heat pump (combined cycle plant)	0.54	0.61	0.54	0.76	0.53	0.38	9.4	9.4
Domestic heat pump (cogeneration combined cycle power)	0.54		0.45	0.45	0.53	0.38	12.9	9.2
District heat pump (hydropower)	0.88	0.61	0.54	0.76	0.53	0.38	15.4	15.4
Domestic heat pump (hydropower)	0.88		0.45	0.45	0.53	0.38	21.2	15.1

Figure 10 and Table 2 responds to a basic question asked by the architect. Since exergy is higher at a higher heating temperature why is it interesting to use low temperature heating systems like floor heating? Exergy

analysis provides a coherent answer. As shown in [7] the overall exergy efficiency can be obtained by multiplying the exergy efficiencies of each subsystem.

$$\eta = \eta_1 \eta_2 \eta_3 \eta_4 \tag{26}$$

Example: Combined cycle power plant without cogeneration (1) + District heating heat pump (2) + DH heat exchanger in the building (3) + Convector (4).

$$\eta = \left(\frac{\dot{E}_{el,1}^-}{\dot{E}_{y,1}^+} \right) \left(\frac{\dot{E}_{y,2}^-}{\dot{E}_{el,2}^+} \right) \left(\frac{\dot{E}_{y,3}^-}{\dot{E}_{y,3}^+} \right) \left(\frac{\dot{E}_{q,4}^-}{\dot{E}_{y,4}^+} \right) = \frac{\dot{E}_{q,4}^-}{\dot{E}_{y,1}^+} \tag{27}$$

Table 11 illustrates the case for cooling.

The net conclusion from such analysis and which corresponds well to the second Law of thermodynamics is:

Heat at the lowest temperature as possible and cool at the highest temperature as possible

Table 11 Examples of overall technologies for air-conditioning [8]

Power plant technologies	Power plant	Dist. plant	Building plant			Room convector			Overall exergy efficiency [%]		
			10°/15°	5°/10°	0°/5°	10°/15°	5°/10°	0°/5°	10°/15°	5°/10°	0°/5°
Supply/return temperatures											
Nuclear power	0.32		0.4	0.4	0.4	0.56	0.43	0.34	7.1	5.4	4.3
Gas motors	0.36		0.4	0.4	0.4	0.56	0.43	0.34	8.1	6.2	4.9
Combined cycle power plant without cogeneration	0.54		0.4	0.4	0.4	0.07	0.07	0.07	12.1	9.3	7.3
Hydropower	0.88		0.4	0.4	0.4	0.53	0.38	0.33	19.8	15.2	12.0

Further application of the concept of exergy efficiency that is often motivating students is the application to vehicle drives as shown in [9,10] where alternative of power drives from electric to liquid nitrogen cars and others are compared. Estimates of exergy efficiencies of electric cars of the order of 69% (without accounting for the efficiency of power generation) are compared with an average of 18% for thermal engine cars based on road tests. In [10] these values are introduced into regional energy scenarios to estimate the future influence on the electricity consumption for example.

5. AI platform for teaching exergy

An attempt was made to apply an AI emerging platform [11] to assist educators. It was applied to the first part of this paper noticing that this beta version did not yet allow equations in a MS Word environment so those had to be described in a written format. However, this early approach illustrates the potential interest of this fast-developing tool at a time where ex-cathedra courses are recognized to be inefficient. The platform proposes a number of tools including automatically generated glossary, concept cards, Quiz, Drag the word, flash cards and crosswords that the author can then freely modify to increase the accuracy or the pertinence.

Drag the words into the correct boxes

- **Carnot Coefficient**: The multiplicative factor that determines the maximum work that can be produced from a heat rate
- **Carnot Cycle**: A thermodynamic cycle that consists of two isothermal and two adiabatic processes
- **Carnot Efficiency**: The maximum efficiency of a heat engine that operates between two given temperatures
- **Coefficient of Performance**: The ratio of the energy output of a system to the energy input of a system
- **Cylinder-Piston Device**: A device used to represent energy storage by initially pressurizing an inert gas like air
- **Energy Storage Term**: The time derivative of the total internal energy of the system Ucz together with the rate of variation of its volume multiplied by the pressure of the atmosphere PadV
- **Exergy Efficiency**: The ratio of the exergy output to the exergy input of a system
- The **Exergy Loss**es taking place in the system
- The corresponding notion of **Exergy Transformation** grouping the flow exergy and storage exergy terms for each network
- **First Law of Thermodynamics**: The energy balance given by the equation: Energy In = Energy Out + Energy Stored

- Coefficient of Performance
- Exergy Efficiency
- Cylinder-Piston Device
- Carnot Coefficient
- Carnot Efficiency
- Carnot Cycle
- Energy Storage Term
- Exergy Transformation
- First Law of Thermodynamics
- Exergy Loss

0/10 C Retry

Figure 10. Non modified proposal from the platform for a “drag the word” exercise

Figure 10 shows one of the “Drag the word” proposal with here the solution superposed in green. Some of the definition obviously need to be improved but the structure is there and the effort from the educator is significantly reduced. Figure 11 provides another presentation with the crossword that can break the monotony during the course. Here again some definitions need to be improved. Of particular interest is the 40 questions with multiple choice of answers among which about one third still need to be discarded, mainly because they refer to the descriptive of equations that are not ideal at this stage.

One additional benefit for the educator could be to highlight the parts of his paper that are not clear enough and need to be improved.

Conclusions

Teaching exergy for a broad range of users is still a challenge. The approach proposed in this paper tries to have a rigorous symmetry between the First Law balance and the exergy balance in cases of open systems with a clear distinction between state functions and process-dependent entities. Applications linked to the ranking of technology combinations for heating and air-conditioning are, among others, good examples for the use of the exergy concept. Finally, an attempt is made to exploit for teaching purposes the fast-developing use of AI tools with the present limitations.

Across

2 the science dealing with the study of matter, as well as that of all phenomena involving work, heat and energy in general. (14)

3 a chemical process that involves the reaction of a fuel and an oxidizing agent, typically oxygen in the air, resulting in the release of heat (and light). (10)

4 an exergy state function that represents the maximum work that can ideally be recovered from the enthalpy H of each mass-flow crossing the boundary of a system. (10)

5 a thermodynamic property that is proportional to the amount of energy in a system or crossing its boundary that is unavailable for doing work. (7)

6 a measure of the maximum useful work that can be obtained from a given amount of energy in a given environment. (6)

7 an exergy state function that represents the maximum work that can ideally be recovered from the energy stored in a system, the latter including the internal energy U and the potential work exchange with the atmosphere PaV. (8)

Down

1 a physical quantity that measures the degree of hotness or coldness of a substance. (11)

7/7 [Show solution](#) [Try again](#)

Figure 11. Example of crossword generated by the platform (text yet unmodified)

References

- [1] Borel L., Favrat D., Thermodynamics and energy system analysis. EPFL Press, Lausanne, Switzerland; 2011
- [2] Batato M., *Energétique du corps humain*. Ed. PPUR, Lausanne, 1989. ISBN 2-88074-177-7
- [3] Nielsen S.N., Müller F., Marques J.C., Bastianoni S., Jorgensen S.E., Thermodynamics in Ecology - An introductory Review. *Entropy* 2020;22(820).
- [4] Rufer A., *Energy storage*. CRC Press, London UK; 2018
- [5] Favrat D., Kane M., From the fuel heating values to the fuel exergy value in advanced energy systems. In ECOS 2023: Proceedings of the 36th International Conference on Efficiency, Cost, Optimization, Simulation and Environmental impacts of Energy Systems, 2023 June 25-30; Las Palmas de Gran Canaria (Spain).
- [6] Moran M.J., Shapiro H.N., Boettner D.D., Bailey M.B. *Fundamentals of engineering thermodynamics*. Wiley 9th edition, US; 2018.
- [7] Favrat D., Marechal F., Exergy representation in thermodynamics. In: Meyer J.P. editor. HEFAT 2015: Proceedings of the 11th International Conference on Heat Transfer, Fluid Mechanics and Thermodynamics, Skukuza, South Africa, 2015 July 20-23. (ISBN: 978-1-77592-108-0)
- [8] Favrat D., Marechal F., Epelly O., The challenge of introducing an exergy indicator in a local law on energy. *Energy* 2008;33(2):130-136
- [9] Iglesias A., Favrat D., Comparative exergy analysis of compressed air, liquid nitrogen and classical power cycle for urban vehicles. In: ECOS 2013: Proceedings of the 26th International Conference on Efficiency, Cost, Optimization, Simulation and Environmental impact of Energy Systems, 2013 July 16-19; Guilin (China).
- [10] Codina V., Allais M., Favrat D., Vuille F., Marechal F. Exergy assessment of future energy transition scenarios with application to Switzerland. In: ECOS 2017: Proceedings of the 30th International Conference on Efficiency, Cost, Optimization, Simulation and Environmental impact of Energy Systems; 2017 July 2-6, San Diego, USA
- [11] Nolej.io (tested on May 1, 2023)